

PI85 with socket GZT80 interface relays

RM85 + GZT80



- Interface relay **PI85 with socket GZT80**, designed for continuous operation*, consists of: electromagnet relay **RM85**, grey plug-in socket **GZT80**, signalling / protecting module type **M...**, retainer / retractor clip **GZT80-0040** (plastic), white description plate **GZT80-0035**
- 35 mm rail mount acc. to EN 60715 or on panel mounting with one M3 screw • May be linked with interconnection strip type **ZGGZ80**
- Recognitions, certifications, directives: recognitions RM85, RoHS,



Contact data

Number and type of contacts		1 CO
Contact material		AgNi , AgNi/Au hard gold plating, AgSnO ₂
Rated / max. switching voltage	AC	250 V / 300 V
Min. switching voltage		5 V AgNi, 5 V AgNi/Au hard gold plating, 10 V AgSnO ₂
Rated load (capacity)	AC1	16 A / 250 V AC ❶
	AC15	3 A / 120 V 1,5 A / 240 V (B300)
	DC1	16 A / 24 V DC (see Fig. 3)
	DC13	0,22 A / 120 V 0,1 A / 250 V (R300)
Motor load	acc. to UL 508	1/2 HP 240 V AC, 4,9 FLA, single-phase motor ❷
	AC3 acc. to IEC 60947-4-1	0,5 kW 240 V AC, single-phase motor
Min. switching current		5 mA AgNi, 2 mA AgNi/Au hard gold plating, 10 mA AgSnO ₂
Max. make current		30 A
Rated current		16 A
Max. breaking capacity	AC1	4 000 VA
Min. breaking capacity		0,3 W AgNi, 0,05 W AgNi/Au hard gold plating, 1 W AgSnO ₂
Contact resistance		≤ 100 mΩ
Max. operating frequency	• at rated load AC1 • no load	600 cycles/hour 72 000 cycles/hour

Coil data

Rated voltage	50/60 Hz AC	12, 24 , 48, 120, 230 , 240 V
	DC	12, 24 , 48, 110 V
Must release voltage		AC: ≥ 0,15 U _n DC: ≥ 0,1 U _n
Operating range of supply voltage		see Tables 1, 2 and Fig. 4, 5
Rated power consumption	AC	0,75 VA
	DC	0,4 ... 0,48 W

Insulation according to EN 60664-1

Insulation rated voltage		250 V AC
Rated surge voltage		4 000 V 1,2 / 50 μs
Overvoltage category		III
Insulation pollution degree		3
Dielectric strength	• between coil and contacts • contact clearance	5 000 V AC type of insulation: reinforced 1 000 V AC type of clearance: micro-disconnection
Contact - coil distance	• clearance • creepage	≥ 10 mm ≥ 10 mm

General data

Operating / release time (typical values)		7 ms / 3 ms
Electrical life	• resistive AC1 • cosφ • DC L/R=40 ms	> 0,7 x 10 ⁵ 16 A, 250 V AC see Fig. 2 > 10 ⁵ 0,15 A, 220 V DC
Mechanical life (cycles)		> 3 x 10 ⁷
Dimensions (L x W x H)		80 x 15,6 x 67 mm
Weight		61 g
Ambient temperature	• storage (non-condensation and/or icing)	-40...+85 °C coil AC: -40...+70 °C coil DC: -40...+85 °C
Cover protection category		IP 20 EN 60529
Environmental protection		RM85: RTII GZT80: RT0 EN 61810-1
Shock resistance		30 g
Vibration resistance		10 g 10...150 Hz

The data in bold type relate to the standard versions of the relays. *The relays are designed for continuous operation while maintaining the parameters declared in the data sheet. ❶ Loads above 12 A require bridging pairs of screw terminals: 11 with 21, 12 with 22, 14 with 24 - see page 2. ❷ For single phase motors for 110-120 V AC do not use motors with higher FLA than given for 240 V AC.

PI85 with socket GZT80 interface relays

Dimensions

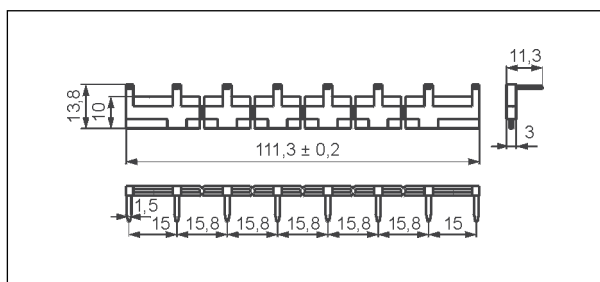
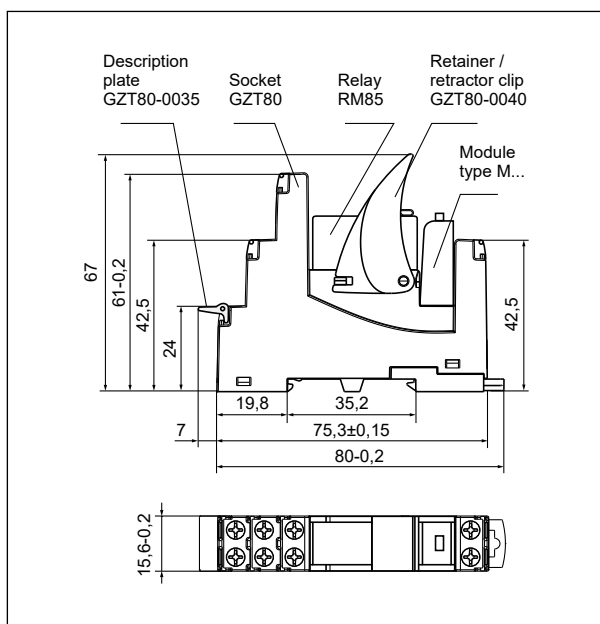

Interconnection strip type **ZGGZ80**

Connection diagrams (screw terminals side view)

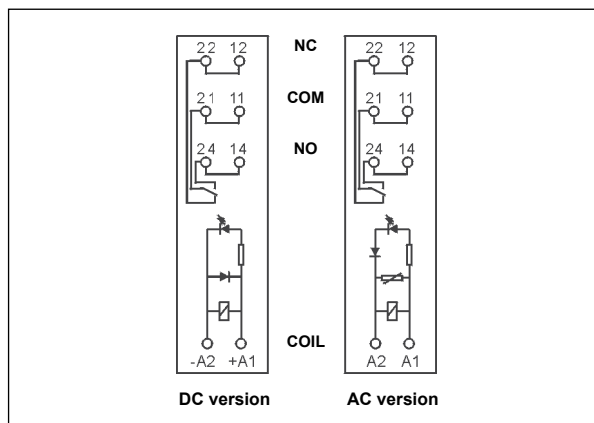

Connection of GZT80 socket

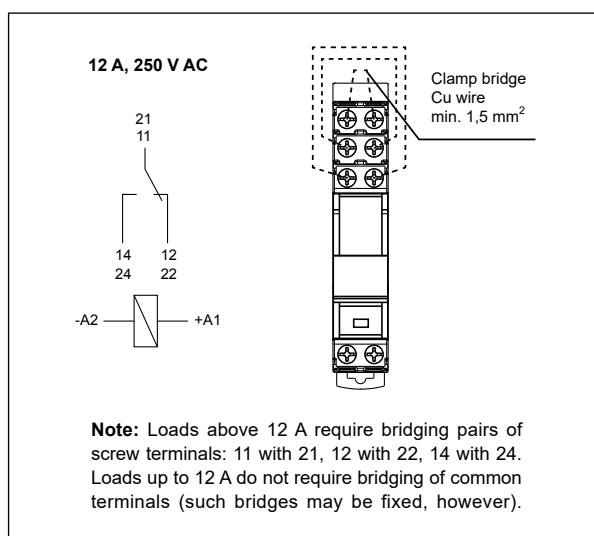

Mounting

Relays **PI85 with socket GZT80** are designed for direct mounting on 35 mm rail mount acc. to EN 60715 or on panel mounting with one M3 screw. **Connections:** max. cross section of the cables (stranded): 2 x 2,5 mm² (2 x 14 AWG), stripping length: 6,5 mm, max. tightening moment for the terminal: 0,7 Nm.

Plug-in sockets **GZT80** may be linked with interconnection strip type **ZGGZ80**. Strip **ZGGZ80** bridges common input signals, maximum permissible current is 10 A / 250 V AC, possibility of connection of 8 sockets. Colours of strips: **ZGGZ80-1** grey, **ZGGZ80-2** black (see page 5).

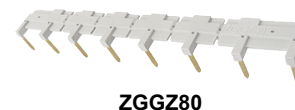
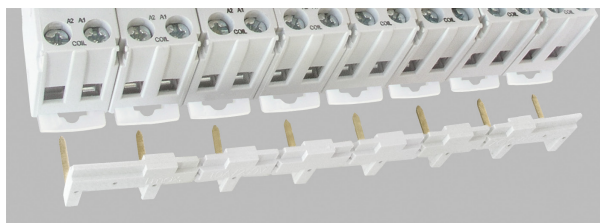

Interconnection strip **ZGGZ80**: bridging of common input signals.

PRECAUTIONS:

1. Ensure that the parameters of the product described in its specification provide a safety margin for the appropriate operation of the device or system and never use the product in circumstances which exceed the parameters of the product. 2. Never touch any live parts of the device. 3. Ensure that the product has been connected correctly. An incorrect connection may cause malfunction, excessive heating or risk of fire. 4. In case of any risk of any serious material loss or death or injuries of humans or animals, the devices or systems shall be designed so to equip them with double safety system to guarantee their reliable operation.

Electrical life at AC resistive load.
Switching frequency: 600 cycles/hour

Fig. 1

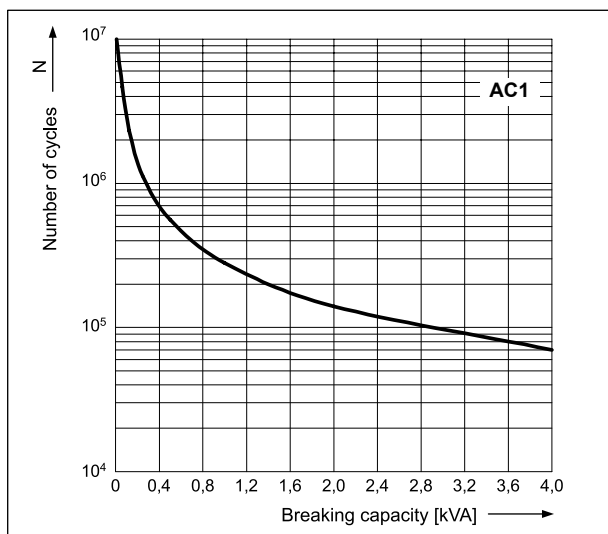

Electrical life reduction factor at AC inductive load

Fig. 2

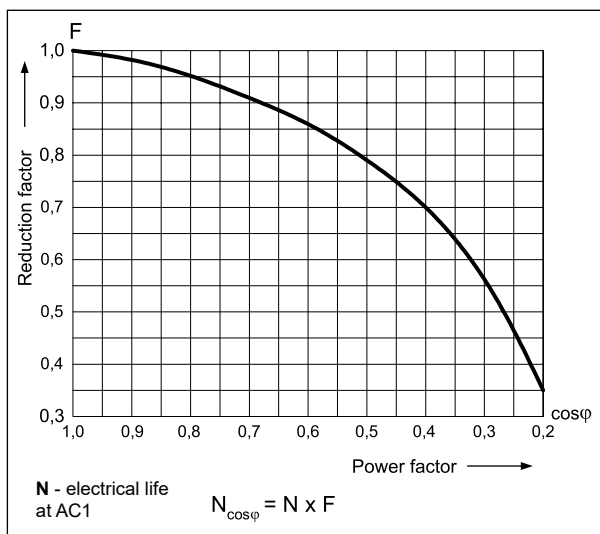

Max. DC resistive load breaking capacity

Fig. 3

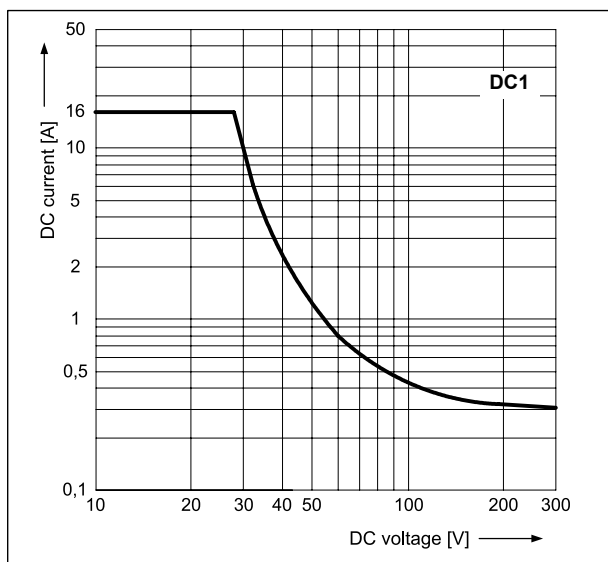

Coil operating range - DC

Fig. 4

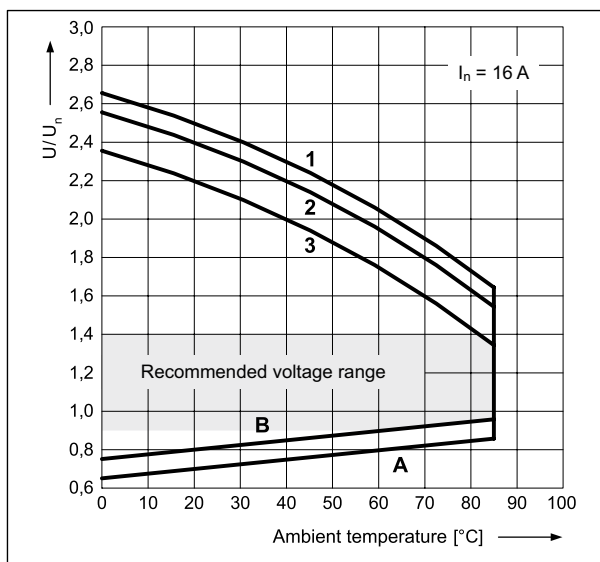

Coil operating range - AC 50 Hz

Fig. 5

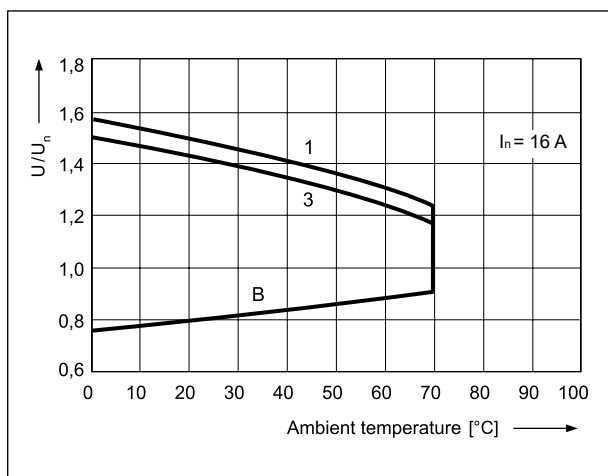

Description of Fig. 4 and 5

Using voltage other than the rated coil voltage may reduce the electrical life of the relay. Figure 4 shows the permissible voltage range for the relay coil, higher coil supply voltages may damage the coil insulation.

A - relations between make voltage and ambient temperature at no load on contacts. Coil temperature and ambient temperature are equal before coil energizing. Make voltage is not higher than the value read on Y axis (multiplication of rated voltage).

B - relations between make voltage and ambient temperature after initial coil heating up with 1,1 U_n , at continues load of I_n on contacts. Make voltage is not higher than the value read on Y axis (multiplication of rated voltage).

1, 2, 3 - values on Y axis represent allowed overvoltage on coil at certain ambient temperature and contact load:

- 1** - no load
- 2** - 50% of rated load in AC1 category
- 3** - rated load in AC1 category

Interconnection strips ZGGZ80



PI85-...-MS-...
(RM85 + GZM80)

ZGGZ80

ZGGZ80 for:

Plug-in sockets	Relays for plug-in sockets	Interface relays ¹
GZT80	RM84, RM85, RM85 inrush, RM85 105 °C sensitive, RM87L ² , RM87P ² , RM87N ²	PI84-...-TS-... (RM84 + GZT80)
GZM80		PI84-...-MS-... (RM84 + GZM80)
GZS80		PI85-...-TS-... (RM85 + GZT80)
GZT92		(RM85 inrush + GZT80)
GZM92		PI85-...-MS-... (RM85 + GZM80)
GZS92		
ES 32	RM96 1 CO	

¹ Interface relay **PI84 (PI85)** is offered as a **set**: electromagnetic relay **RM84 (RM85)** + plug-in socket **GZT80** or **GZM80** + signalling / protecting module type **M...** + retainer / retractor clip **GZT80-0040** + description plate **GZT80-0035**. ² Also versions RM87. sensitive

Interconnection strip ZGGZ80

- designed for the co-operation with plug-in sockets of miniature relays and with interface relays PI84 and PI85, which are equipped with screw terminals; sockets and relays are mounted on 35 mm rail mount acc. to EN 60715,
- bridges common input signals (coil terminals A1 or A2) or output signals - see photo at the top,
- maximum permissible current is 10 A / 250 V AC,
- possibility of connection of 8 sockets or relays,
- colours of strips: **ZGGZ80-1** grey, **ZGGZ80-2** black.

